

mogogo



2025 CATALOG

Modular

SYSTEM

DISTRIBUTED BY:







INDEX

4	About Mogogo
8	About Modular Collection
9	Materials
10	How It Works
12	Details
14	Live & Action Stations
22	Buffet Stations
28	Bars and Back bars
34	Hot and Cold Buffet
45	Transfer & Storage Carts
46	System Breakdown

 New Products

 Chef

 Waiter

 Bartender

 See Page

modoo

A MODULAR F&B
FURNITURE BRAND



OUTDOORS

BORN FROM A PASSION FOR **STYLE & GASTRONOMY**



Mogogo is led by designers and chefs that are aiming to introduce innovative, luxurious, and highly functional equipment to foodservice professionals.



MODULAR



MOBILE



SUSTAINABLE



ADD ONS



THE BAR IS OPEN



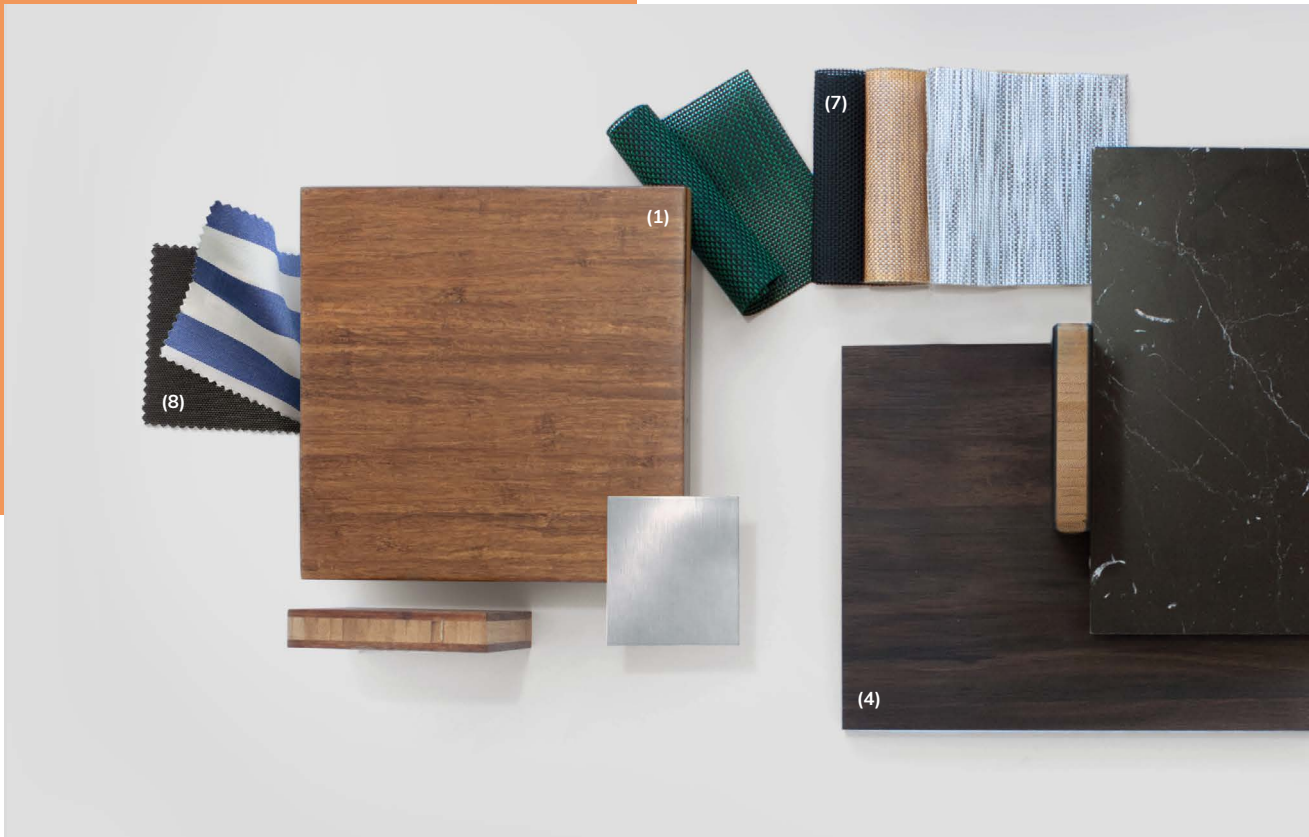

ABOUT MODULAR COLLECTION

Mogogo's flagship collection, the Modular System, allows you to use the same components in various ways to create endless configurations. Our Modular System contains the Classic and Creative Ranges, supported by a large variety of add-ons.

Our Classic Range consists of basic units and shelves that fit each other seamlessly, functioning as building blocks to the Modular System. It is characterized by a sleek linear design, adaptable to both traditional and more modern look.

The Creative Range is composed of curved and straight units which fits seamlessly together. The Creative system is patented and offers unique features based on our vast experience in large food service operations.

Mogogo's F&B stations are carefully designed, maintaining a delicate balance between functionality, durability, and mobility; all in perfect symbiosis with high design standards, providing an ideal solution for the hospitality industry.



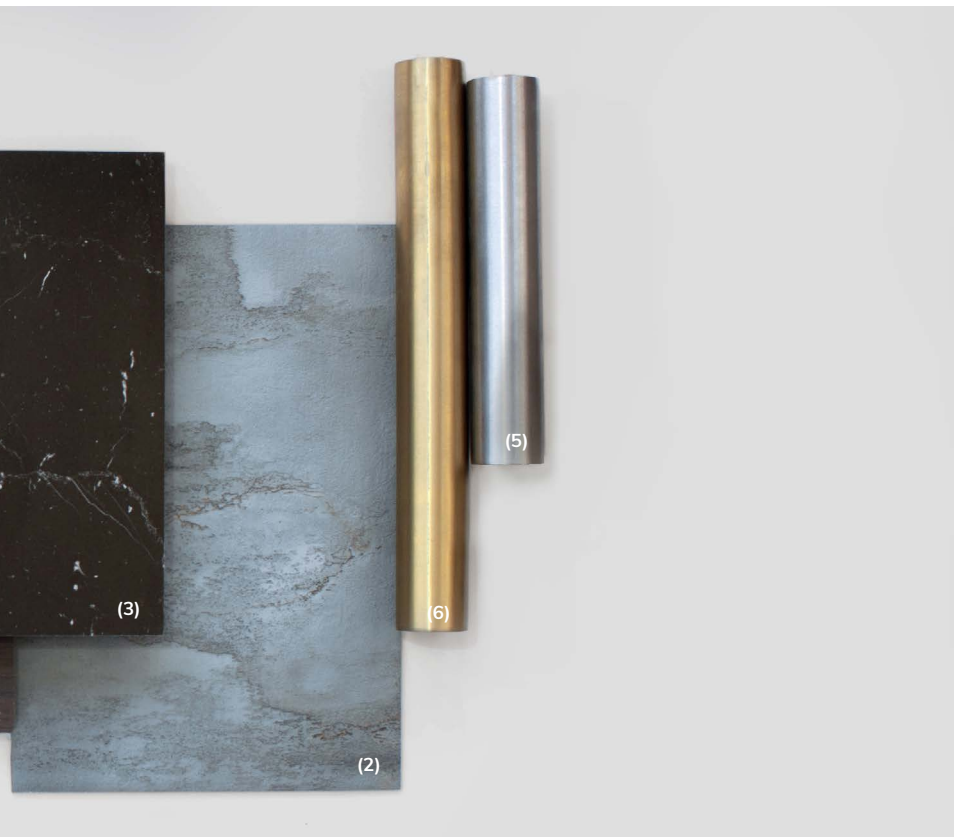

MATERIALS

Joining our Bamboo **(1)** collection is our innovative BHP material. BHP is a newly composed material that arrived after two years of intense R&D. It merges layers of High-Pressure Laminate with a Vertical Bamboo core (Mogogo's expertise) creating a lighter yet durable panel that offers new textures and colors. This new material combines the advantages of both bamboo and HPL, perfect for the ever-changing needs of the hospitality industry. BHP is available in a variety of finishes that resemble natural materials such as Grey Slate, Nero Marquina Marble, and Bengali Mango Wood **(2-4)**, making it easy to match with any event and decor. The innovative bamboo core of the BHP goes in line with Mogogo's sustainability motto while the HPL's outer coating is durable for different environments, hygienic and easy to clean.

Modular segments come in 2 finishes:
brushed stainless steel **(5)** and brushed brass **(6)**.

Easily cover up parts of your buffet stations with our original quick covers **(7)**. Both durable and easy to clean, they come in 4 different color options allowing you to easily match any of your event color schemes.

For that extra outdoor feel, add a canopy **(8)** to your buffet station, made from a sturdy Cordura fabric known for its resistance to abrasions, tears, and scuffs.

MATERIAL GUIDE

Customize your Modular Stations by choosing from the different colors and finishes available. Simply choose your preferred design combination by inserting the corresponding letter to its designated space as demonstrated below.

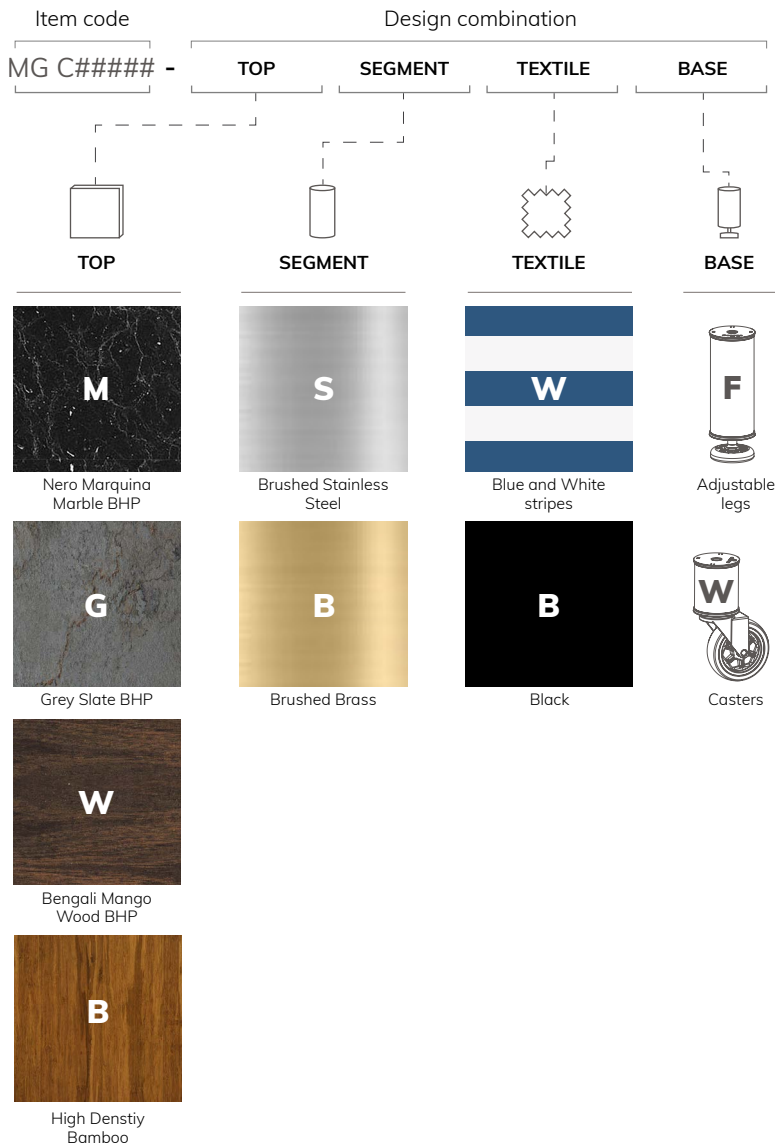

EXAMPLE:

MG CMLB10 **G** **B** **W** **F** =





HOW IT WORKS

The Mogogo Modular System is based on parts, which can be combined to create endless configurations. These individual components sit at the core of the Mogogo Modular System. They are utilized as the base for creating Action Stations, Buffet Stations, Bar Stations, and more when combined with add-ons, to offer the perfect customized touch for all of your hospitality needs.

All Stations have essential elements: tabletops, mid-part segments, and leg segments (permanent or mobile casters). You can choose your add-ons: different shelves, signposts, quick covers, arches, etc., for the ultimate customization.

What is unique about the modular System is the freedom of building any F&B station you wish from the same parts. Start with a Basic Station and add shelves: it makes for the ideal Breakfast Station. Add a different tabletop and covers; it becomes an elegant Bar Station. All this is done with one Allen ranch in a matter of minutes.

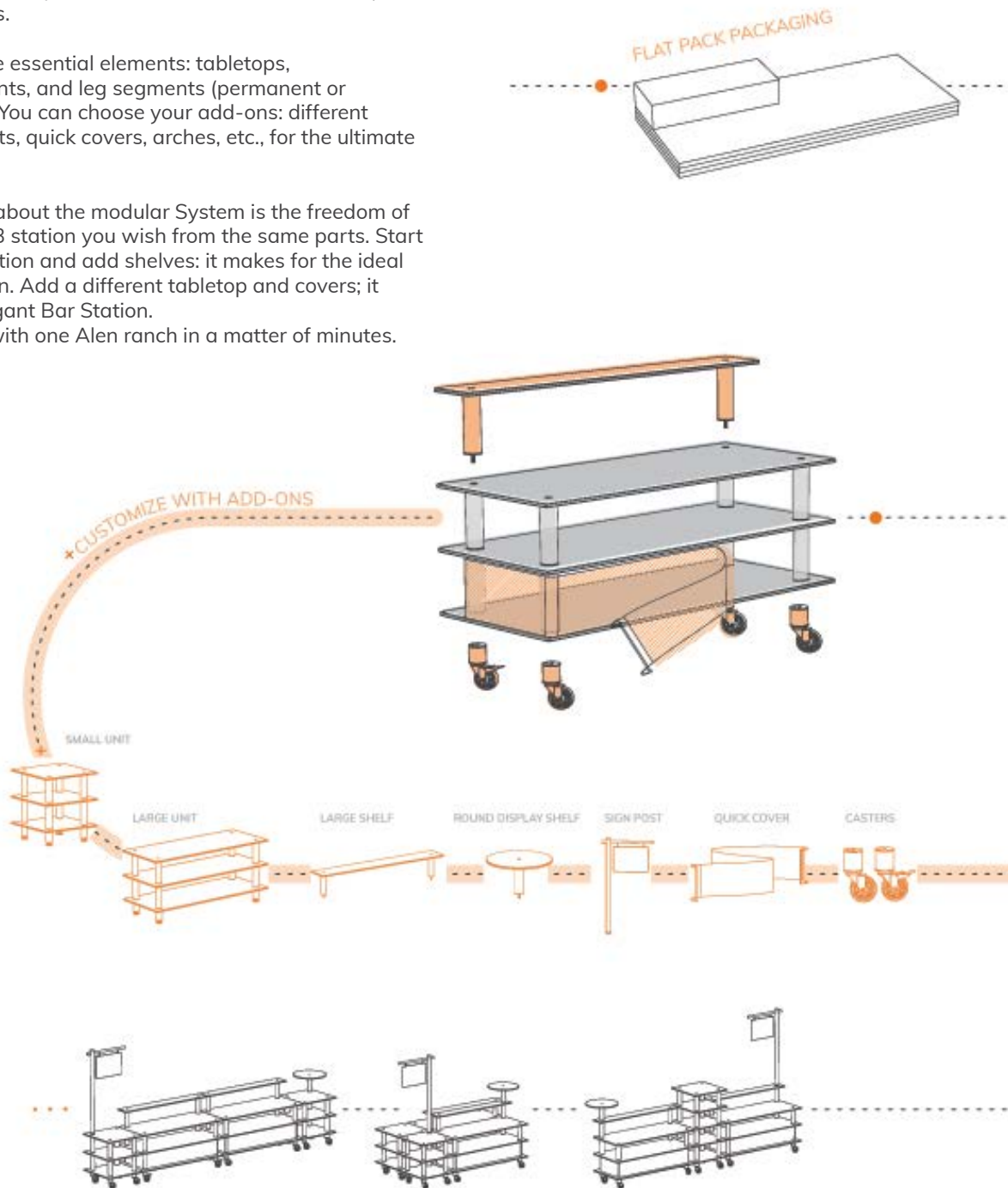

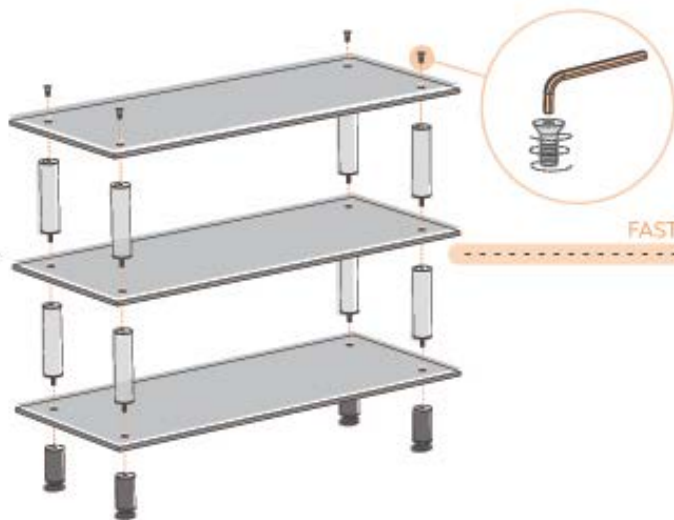

FAST AND EASY ASSEMBLY

LARGE UNIT



THE BREAKFAST CORNER

CREATE ENDLESS CONFIGURATIONS FROM THE SAME PARTS ACCORDING TO YOUR NEEDS



DETAILS







STREAMLINE ARCH INDUCTION STATION MG CMLD05 MSXW

(shown with optional Charcoal-Black quick covers)



OPEN C SERVING STATION MG CMSA01 WBXF
(shown with optional Golden-Brown quick covers)

LIVE & ACTION STATIONS

Guests' fascination with chefs, food preparation, and presentation around the action station continues to grow and evolve in events today - it's a great way to add some spice and surprise to your culinary landscape.

Mogogo's Action Stations are designed to enhance the interactive experience of your guests through elegant design, while providing chefs and F&B professionals all the functional elements they are looking for. From an omelet station to a make-it-your-own dish station, Mogogo Action Stations are extremely modular; our ever-expanding line of add-ons and a wide range of tabletops deliver functionality and authenticity.

Cooking in front of the guest entices all their senses - and we believe beautifully crafted furniture is part of the experience.

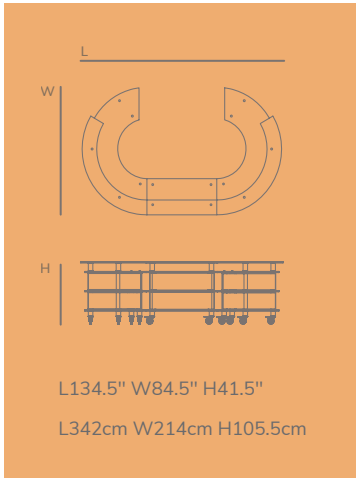

OPEN C SERVING STATION

Neither round nor square, this station creates a minimalist and functional approach, designed to serve large crowds with minimal effort.

MG CMSA01 W S X W

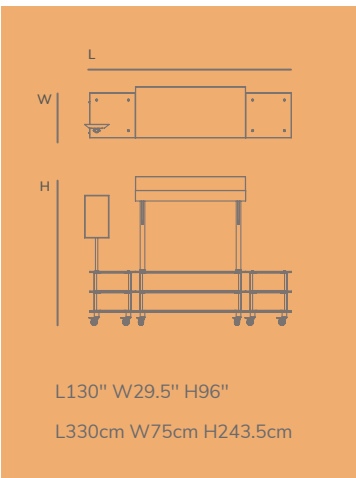

NEW



INTERACTIVE STATION

A unique station within Mogogo's offer, with the ability to place a large screen on a designated pole. Great for showing a day's menu, ambiance video, or anything else. The station can be for self-service or with a waiter serving food behind.

MG CMLA12 G S W W

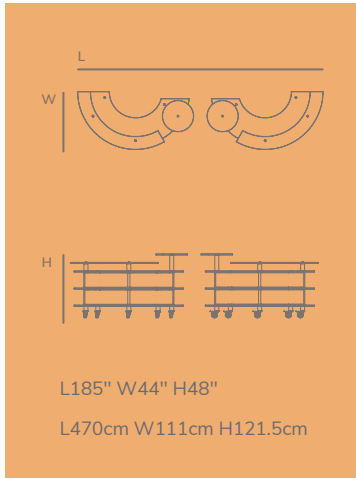

DOUBLE U SERVING STATION

The Double U serving station is a highly functional buffet, which can be used as both a self-service buffet station and an action station, respectively. As a bonus, those two half rounds can become other configurations easily, an S station or a complete Round station.

(shown with optional Jungle-Green quick covers)

MG CMSA08 G S X W

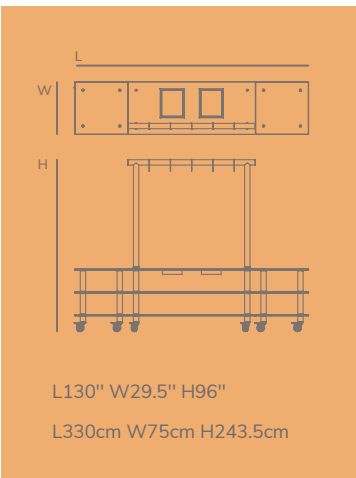

LARGE ARCH INDUCTION STATION

Combining drop-in induction ranges with additional space for mise en place - the ultimate comfort for chefs.

(shown with optional Golden-Brown quick covers and Long Blackboard)

MG CMLD02 W S X W



BAZAAR ACTION STATION MG CMLA03 GSWW
(shown with optional Silver-Grey quick covers)





SMALL S BUFFET MG CMSB03 GSXW
(shown with optional Large Oval high display shelf and Small Oval low display shelf)



BUFFET STATIONS

As a fundamental functional element to any F&B operation, we believe Buffet Stations no longer need to be hidden under linens nor lifted by the staff.

Mogogo takes an innovative and sustainable approach to Buffet Stations by introducing new designs and functionality for linenless F&B Furniture, revealing beautiful clean lines.

The presentation of a station is just as important as the aesthetic of the food being served and Mogogo offers ideal solutions for Chefs to display their most exquisite dishes. From Classic to Creative, Mogogo Buffet Stations offer a wide range of display and self-service options. Above, add shelves to elevate the dining experience of your guests; below, add our Quick Covers to conceal extra storage space.

Maximize every corner of your catering space by mixing and matching our Classic Range and Creative Range to reinvent the experience of self-service in events.

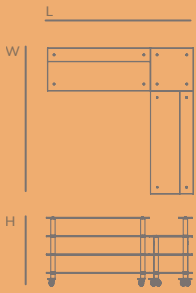

L100.5" W100.5" H47.5"
L255cm W255cm H121cm



PRO CORNER STATION

Make the best use of space with this classic corner buffet station which gives all the advantages of a Mogogo station without taking up extra event space.
(shown with optional Golden-Brown quick covers)

MG CMLB05 W S X W

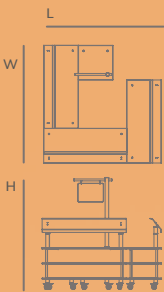

L100.5" W100.5" H94"
L255cm W255cm H238.5cm



SELF SERVICE SALAD STATION

Make a statement in any event with this large food station equipped with protective self-service high breath guards and a signpost to attract guests.
(shown with optional Silver-Grey quick covers)

MG CMLB06 G S X W

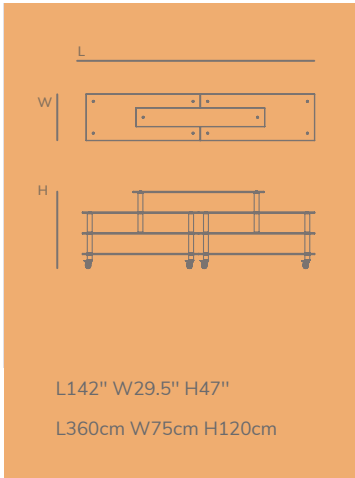

DOUBLE DISPLAY BUFFET

A perfect station for a self-serving buffet with the addition of a shelf that connects the two tables and allows for the elevation of utensils or decoration.

MG CMLB19 B B X W

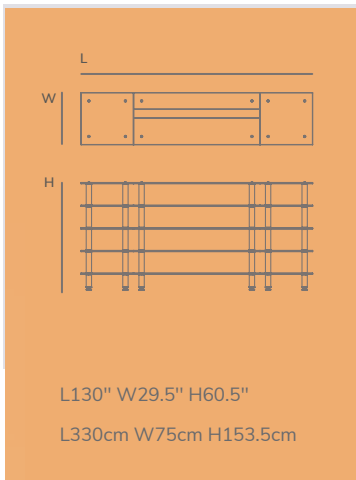

BREAD AND PASTRY STATION

Create a focal point in any event with this extra high buffet station, giving more storage and presentation area than ever before.

(shown with optional Silver-Grey quick covers)

MG CMLB04 M S X F

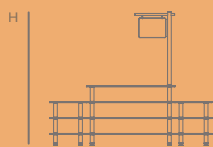
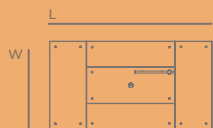

L130" W71" H107"
 L330cm W180cm H272cm



MARKET SQUARE

The classic look and feel of a traditional market with a modern flair gives this configuration all the functionality and practicality a large buffet station needs.

MG CMLB07 W B X F

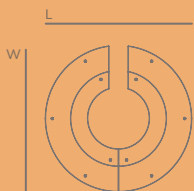

L82" W81.5" H41.5"
 L208cm W207cm H105.5cm



ROUND MARKET

Acting not only as the event's focal point, this 360-degree buffet experience will also prevent chaotic queues.

MG CMSB01 M S X W

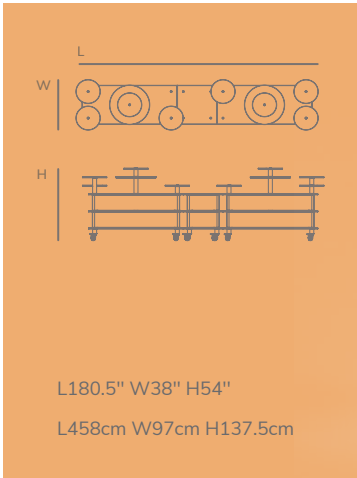

MULTI HEIGHT DISPLAY STATION

Create unforgettable events with this eye-catching display station, scattered with interchangeable display shelves in different heights. (shown with optional Charcoal-Black quick covers)

MG CMLB08 M B X W

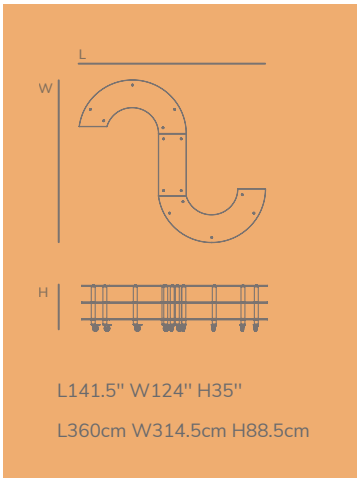

MEDIUM S BUFFET

Avoid hectic buffet lines with Mogogo's Creative S station which gives a smooth crowd flow in any event.

MG CMSB02 B S X W



ALL STAINLESS PRO BAR MG CMLC06 MSXW
(shown with optional Charcoal-Black quick covers)



BARS & BACK BARS

Redefine guests' expectations in any F&B operation by elevating their beverage standards. From classic wine bars to mixology & curated cocktails - Bar & Back Bars across your venue are an opportunity to make a statement.

Mogogo's Bar & Back Bars section features highly adaptable configurations which can be used in a wide range of event types and sizes. Easily transportable from one venue to other thanks to their heavy-duty casters, Mogogo Bar & Back Bars combine sleek design and high functionality.

Customize your Bar with our versatile Add-Ons and quickly conceal bottom shelves for additional storage with our Quick-Covers. For guests or bartenders, everything in F&B is about the experience. Mogogo Bar & Back Bars delivers on the promise of innovative functional design.



L
W
H

L71" W29.5" H60.5"
L180cm W75cm H153.5cm



L
W
H

L71" W40" H47.5"
L180cm W102cm H121cm

PRO BAR & BACK BAR STATIONS

The Pro Bar is equipped with a stainless steel working surface, ice bin and speed-rail. Combined with a Mogogo back bar, it's a bartender's dream.

(shown with optional Silver-Grey quick covers)

PRO BAR MG CMLC05 M S X W

BACK BAR MG CMLC02 M S X W



L
W
H

L130" W29.5" H60"
L330cm W75cm H153cm



L
W
H

L130" W40" H47.5"
L330cm W102cm H121cm

PRO AND BACK BAR WITH EXTENDED CORNERS

A stunning combination of a Pro Bar and a Back Bar with rounded corners on the sides makes it an attraction your guests won't be able to ignore.

MG CMLC13 W S X W

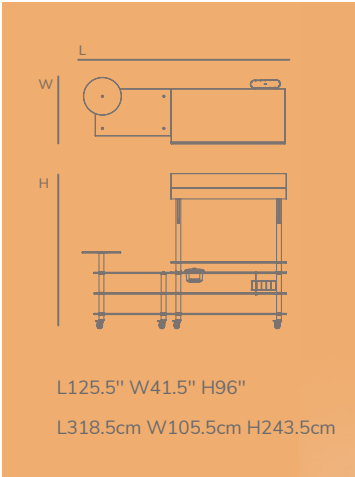

MIXOLOGY BAR STATION

Designed to accommodate the most sophisticated Mixologists, this is the ultimate design element for a show-stopping cocktail mixing experience.

(shown with optional Charcoal-Black quick covers)

MG CMLC07 G S B W

NEW

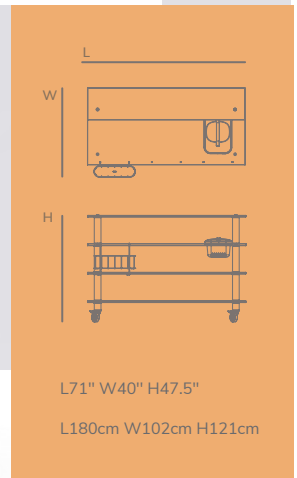
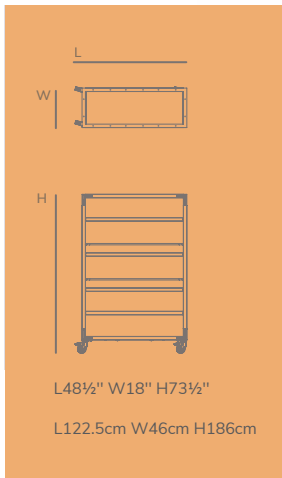

PRO BAR CANVAS BACK BAR

The best of two worlds, our Pro Bar a best seller in the Modular collection and the perfect Canvas Back Bar, combined together with the jungle green covers to make it a perfect pair.

(shown with optional Jungle-Green quick covers)

CANVAS BACK BARMG CCAN23 D C X W

PRO BARMG CMLC05 M S X W









HEAT TABLE MG CMLD06 WSXW
(shown with optional Jungle Green quick covers)

HOT & COLD BUFFET

The visual appeal of the colors and textures of the food, the aroma as it is prepared, and the sounds of sizzling pans... Cooking and Warming Stations generate excitement, curiosity, and can be a great catalyst for social interaction.

Now, Cooking and Warming Stations are redesigned as one modern and beautifully crafted element to seamlessly blend with your hospitality design standards. Designed as a modular extension to our existing function-based tabletops, Mogogo Cooking and Warming Stations offer your chefs high-functionality, mobility, and add a sense of theater for a special catering experience.

Your guests want creativity and variety. Introduce them to new culinary territories and let them discover new sensations with Mogogo's Cooking and Warming Stations.

NEW

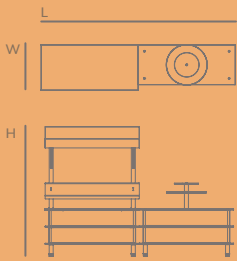

L142" W33.5" H96"
L360cm W85cm H244cm



FRESH DISPLAY STATION

Seafood, meat, and fruits can be displayed on ice under the canopy in an inviting presentation resembling an authentic market, while side by side those Ingredients can be served on the round shelves to complete the show.

MG CMLE05 M S W F

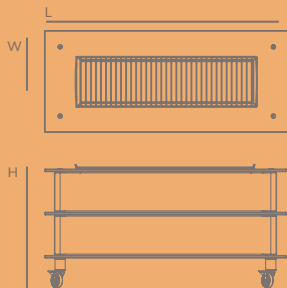

L71" W29.5" H35"
L180cm W75cm H88.5cm



HEAT TABLE

With a great look and no need for an electric plug. This station uses canned heat to keep food warm during entire events while delivering a grill-style ambient.

(shown with optional Charcoal-Black quick covers)

MG CMLD06 W S X W

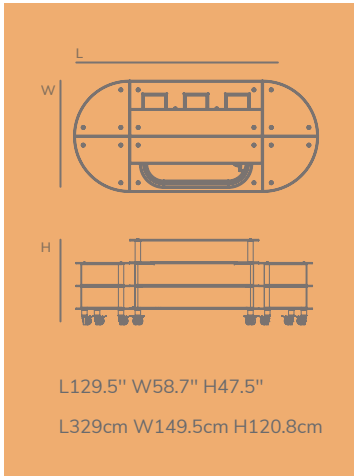

HOT AND COLD MARKET

A large buffet setup offering both warm holding and a large ice bin to present chilled items. the center shelf is aimed to be decorated according to the theme used to create the right atmosphere.

MG CMLD20 M B X W

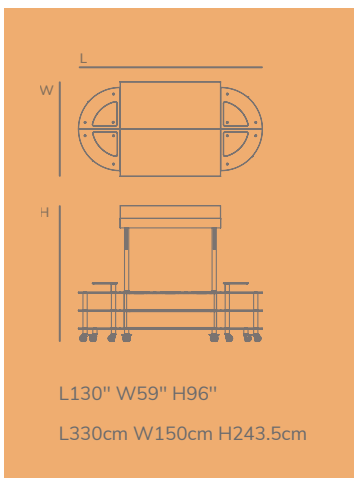

ROUNDED WARMING INDUCTION MARKET STATION

This stand-out station makes serving large crowds easy while keeping food warm on six drop-in induction units.

(shown with optional Jungle Green quick covers)

MG CMLD03 G B W W



PICTURE FROM LUMINARY HOTEL



PRO ICE BIN & MODULAR SYSTEM

Enhance your all-purpose buffet with our versatile cooling solution. Combining functionality and aesthetics, it serves perfectly as a chilled buffet or drinks station, catering to various needs.

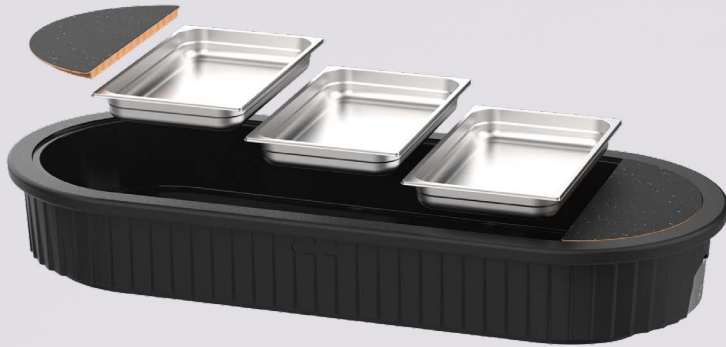

*Shown with optional side trays - item MG STRYBP 0101

*Pans not included

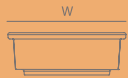

L60" W25" H9"

L151cm W64cm H23cm









SALAD BAR UNIT

Perfect for chilling salad bowls, seafood, or a variety of beverages.

(shown with optional Charcoal-Black quick covers)

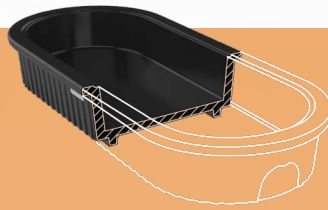

The double wall structure combines durability and great heat isolation.



Behind the spring loaded stainless steel door is a quick disconnect fitting to attach drain hose.



TRANSFER & STORAGE CARTS

Designed for convenience and mobility, Mogogo's utility carts are an integral part of the Modular system as they make storing and assembling the stations an easy task. Whether it is to push them through the halls, or get in and out of elevators, they make the behind the scenes of your time-sensitive events easier and give you an extra push on productivity.

The carts can store up to five large Classic units or four large Creative units while the orange vinyl coated areas ensure comprehensive tabletop protection.

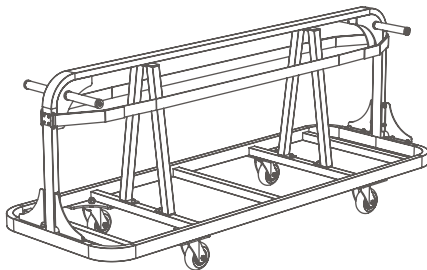

**LARGE PLATE
TRANSFER AND STORAGE CART**
L86.5" W31" H36.5"
L220cm W79cm H92.5cm
holds up to 18 tabletops

MG CUUX03 XXXX



**SEGMENTS AND ADD-ONS
TRANSFER AND STORAGE CART**
L55.5" W31" H50"
L141cm W79cm H127.5cm
holds 7-9 modular unit segments and legs/casters
+ dedicated storage space for multiple modular add-ons

MG CUUX01XXXX









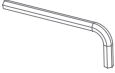

SYSTEM BREAKDOWN

Mogogo's Modular System is based on a wide range of individual parts, which can be stacked up & assembled to design a variety of stations.

Our Modular System stems from the simple idea that your F&B Furniture should adapt to your ever-varying needs during different event sizes, types, and themes. It allows you to pick and choose basic elements such as tabletops, leg segments, casters, shelves, and other add-ons.

Endless vertical and horizontal possibilities exist while choosing between our functional tabletops: from classic to cooking, warming and bar tabletops, or picking your material and finishes of choice. Mogogo's Modular System gifts you an ocean of possibilities.

MOGOGO TOOLS

	1 piece	ALLEN KEY FOR M16	MG SSAUXSS 01	
	1 piece	M16 SCREWS	MG SSCWMT 01	
	1 piece	BLACK SCREW CAP	MG SACPL 06	
	1 piece	GREY SCREW CAP	MG SACPL 05	
	1 piece	BROWN SCREW CAP	MG SACPL 02	
 X1	 X2	 X12	UTILITY KIT: ALLEN KEY FOR M16 2 M16 SCREWS 12 SCREW CAPS (4 Screw caps X 3 colors)	MG SSACSM 01

CREATIVE RANGE

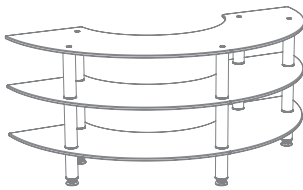

CREATIVE CURVED UNIT
 L81.5" W41" H35"
 L207cm W104cm H88.5cm

MG CMSX01 __ X _

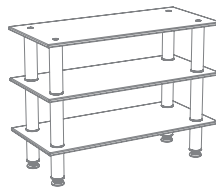

CREATIVE EXTENSION UNIT
 L47" W21" H35"
 L120cm W54cm H88.5cm

MG CMSX02 __ X _

CLASSIC RANGE

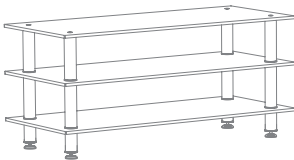

CLASSIC LARGE UNIT
 L71" W29.5" H35"
 L180cm W75cm H88.5cm

MG CMLX01 __ X _



CLASSIC MEDIUM UNIT
 L47" W29.5" H35"
 L120cm W75cm H88.5cm

MG CMLX02 __ X _

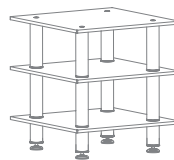

CLASSIC SMALL UNIT
 L29.5" W29.5" H35"
 L75cm W75cm H88.5cm

MG CMLX03 __ X _

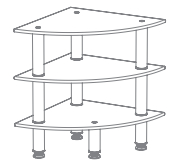

CLASSIC CORNER UNIT
 L29.5" W29.5" H35"
 L75cm W75m H88.5cm

MG CMLX04 __ X _

STANDARD RANGE

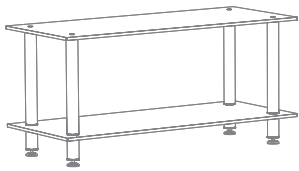

STANDARD LARGE UNIT
L71" W29.5" H35"
L180cm W75cm H88.5cm

MG CMDX01 __ X _

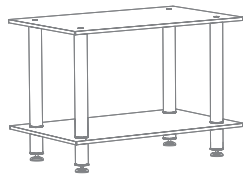

STANDARD MEDIUM UNIT
L47" W29.5" H35"
L120cm W75cm H88.5cm

MG CMDX02 __ X _

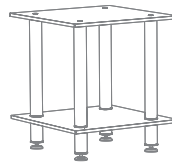

STANDARD SMALL UNIT
L29.5" W29.5" H35"
L75cm W75cm H88.5cm

MG CMDX03 __ X _

CREATIVE RANGE SHELVES

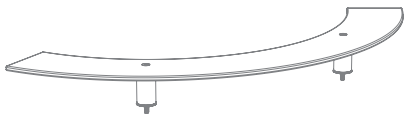

CURVED OUTER SHELF
L76" W27.5" H6.5"
L193cm W70cm H16.5cm

MG CIAF01 __ XX



CURVED INNER SHELF
L53" W26.5" H6.5"
L135cm W68cm H16.5cm

MG CIAF02 __ XX



EXTENSION SHELF
L47" W10" H6.5"
L120cm W25cm H16.5cm

MG CIAF03 __ XX

CLASSIC RANGE SHELVES



LARGE SHELF
L71" W9.5" H12.5"
L180cm W24cm H32cm

MG CIAF04 __ XX



LARGE LOW SHELF
L71" W9.5" H6.5"
L180cm W24cm H16.5cm

MG CIAF05 __ XX



LARGE WIDE BAR SHELF
L71" W14.5" H12.5"
L180cm W37cm H32cm

MG CIAF06 __ XX



MEDIUM SHELF
L47" W9.5" H12.5"
L120cm W24cm H32cm

MG CIAF07 __ XX



MEDIUM LOW SHELF
L47" W9.5" H6.5"
L120cm W24cm H16.5cm

MG CIAF08 __ XX

CLASSIC RANGE DISPLAY SHELVES

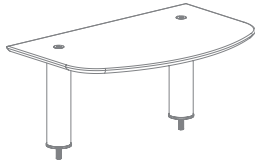

HIGH SIDE SHELF
L29.5" W19" H12.5"
L75cm W47.5cm H32cm

MG CIAY01 __ XX

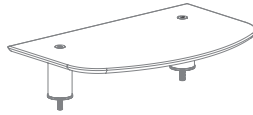

LOW SIDE SHELF
L29.5" W19" H6.5"
L75cm W47.5cm H16.5cm

MG CIAY02 __ XX



WIDE DISPLAY SHELF
L80" W12" H12.5"
L203cm W30.5cm H32cm
connects 2 mid-hole display tabletops

MG CIAY03 __ XX

DISPLAY SHELVES

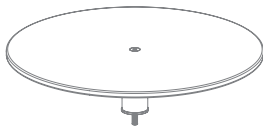

**30" ROUND
LOW DISPLAY SHELF**
Ø30" H6.5"
Ø76cm H16.5cm

MG CIAY04 __ XX

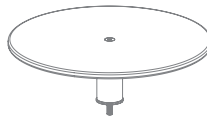

**24" ROUND
LOW DISPLAY SHELF**
Ø24" H6.5"
Ø60cm H16.5cm

MG CIAY05 __ XX

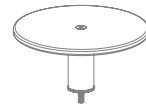

**18" ROUND
LOW DISPLAY SHELF**
Ø18" H6.5"
Ø46cm H16.5cm

MG CIAY06 __ XX

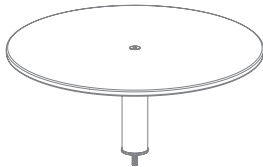

**30" ROUND
HIGH DISPLAY SHELF**
Ø30" H12.5"
Ø76cm H32cm

MG CIAY07 __ XX

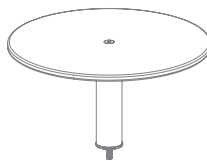

**24" ROUND
HIGH DISPLAY SHELF**
Ø24" H12.5"
Ø60cm H32cm

MG CIAY08 __ XX

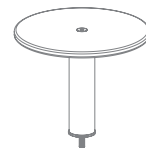

**18" ROUND
HIGH DISPLAY SHELF**
Ø18" H12.5"
Ø46cm H32cm

MG CIAY09 __ XX

DISPLAY SHELVES

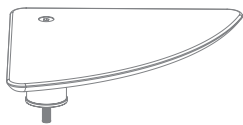

**LARGE TRIANGLE
LOW DISPLAY SHELF**
L17" W17" H6.5"
L44cm W44cm H16.5cm

MG CIAY10 __ XX

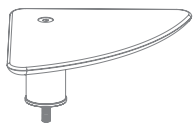

P. 36

**SMALL TRIANGLE
LOW DISPLAY SHELF**
L14" W14" H6.5"
L35cm W35cm H16.5cm

MG CIAY11 __ XX

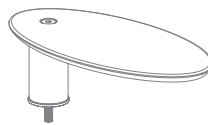

**LARGE OVAL
LOW DISPLAY SHELF**
L20" W10" H6.5"
L50cm W25cm H16.5cm

MG CIAY14 __ XX

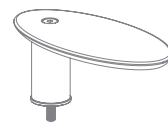

P. 20

**SMALL OVAL
LOW DISPLAY SHELF**
L16" W8" H6.5"
L40cm W20cm H16.5cm

MG CIAY15 __ XX

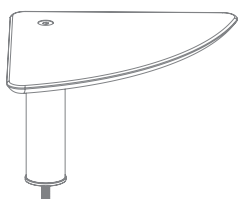

P. 36

**LARGE TRIANGLE
HIGH DISPLAY SHELF**
L17" W17" H12.5"
L44cm W44cm H32cm

MG CIAY12 __ XX

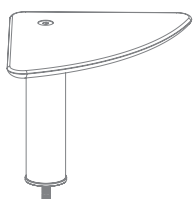

**SMALL TRIANGLE
HIGH DISPLAY SHELF**
L14" W14" H12.5"
L35cm W35cm H32cm

MG CIAY13 __ XX

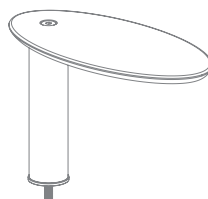

P. 20

**LARGE OVAL
HIGH DISPLAY SHELF**
L20" W10" H12.5"
L50cm W25cm H32cm

MG CIAY16 __ XX



**SMALL OVAL
HIGH DISPLAY SHELF**
L16" W8" H12.5"
L40cm W20cm H32cm

MG CIAY17 __ XX

QUICK COVERS

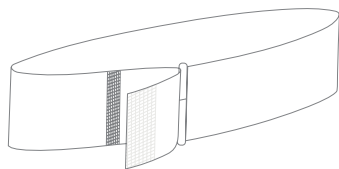

360° QUICK COVERS

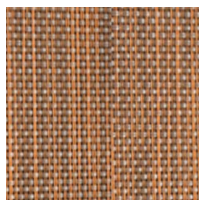

Golden-Brown



Silver-Grey

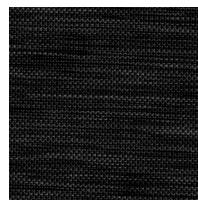

Charcoal-Black

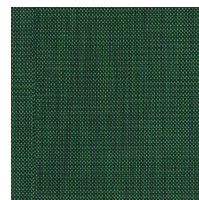

Jungle-Green

LARGE CLASSIC UNIT

2

MG SQCOPV 3401

MG SQCOPV 3301

MG SQCOPV 3201

MG SQCOGP 0801

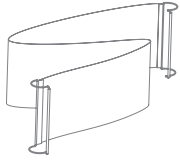

Fits Unit

Amount

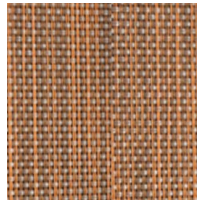

Golden-Brown

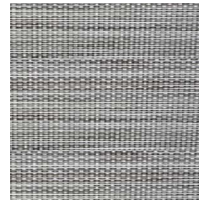

Silver-Grey

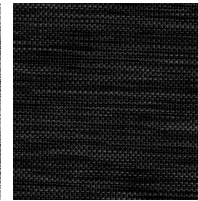

Charcoal-Black



Jungle-Green

Fits Unit	Amount	Golden-Brown	Silver-Grey	Charcoal-Black	Jungle-Green
LARGE CLASSIC UNIT	2	MG SQCOPV 0301	MG SQCOPV 0401	MG SQCOPV 1601	MG SQCOGP 0201
MEDIUM CLASSIC UNIT	2	MG SQCOPV 0501	MG SQCOPV 0601	MG SQCOPV 1701	MG SQCOGP 0301
SMALL CLASSIC UNIT	2	MG SQCOPV 0701	MG SQCOPV 0801	MG SQCOPV 1801	MG SQCOGP 0401
CORNER CLASSIC UNIT	2	MG SQCOPV 2401	MG SQCOPV 2501	MG SQCOPV 2601	MG SQCOGP 1101
CURVED CREATIVE UNIT	2	MG SQCOPV 0901	MG SQCOPV 1001	MG SQCOPV 1901	MG SQCOGP 0501
EXTENSION CREATIVE UNIT	2	MG SQCOPV 1101	MG SQCOPV 1201	MG SQCOPV 2001	MG SQCOGP 0601
LARGE SHELF	1	MG SQCOPV 0101	MG SQCOPV 0201	MG SQCOPV 1501	MG SQCOGP 0101

ADD-ONS

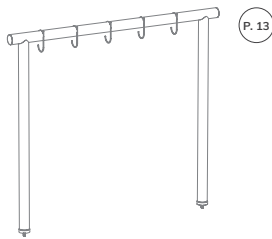

P. 13

ARCH
L71" W3" H61"
L180cm W7.6cm H155cm
Fits large units

MG CIAM02X _ XX

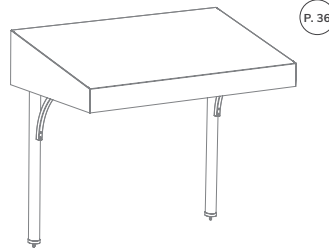

P. 36

CANOPY
L71" W33.5" H61"
L180cm W85cm H155cm
Fits large units

MG CIAM03X _ _ X

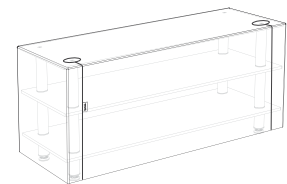

OUTDOOR CORDURA COVER
Fits classic large unit

MG SADDCR 04

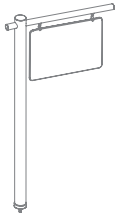

P. 17

SIGN POST
L32" W3" H59"
L80.5cm W7.6cm H150cm
Fits all units
MG CIAM01 X _ XX

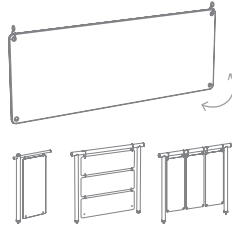

LONG BLACKBOARD
L47" H18"
L120cm H45cm
Fits Arch and Sign post
MG SADDSM 02

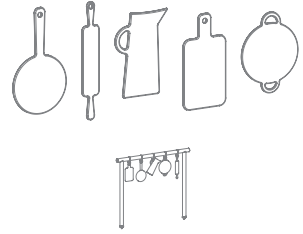

P. 13

BLACKBOARD COLLECTION
5X various shapes
Fits Arch
MG SADDSM 03

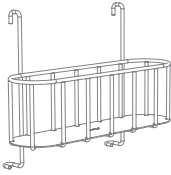

P. 25

SPEEDRAIL
L18.5" W5" H14"
L47cm W13cm H36cm
Fits bar top
MG SADDSS 06

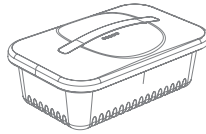

P. 25

MOGOGO ICE BIN
L19.5" H12.5" W8"
L49.5cm H31cm W20cm
Fits Pro bar top
MG SADDPL 03



P. 13

WINE GLASS HOLDER
L15" H2.5" W4.5"
L37.5cm H6.5cm W11cm
Fits Large wide bar shelf
Holds up to 6 wine glasses
MG SADDSS 13

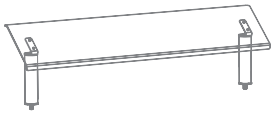

71" BREATH GUARD
H18.5" | gap H8.5"
H47cm | gap H22cm
Fits large units
MG CIAN01 X _ XX



47" BREATH GUARD
H18.5" | gap H8.5"
H47cm | gap H22cm
Fits medium units
MG CIAN02 X _ XX

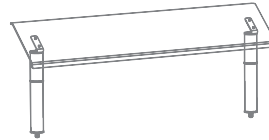

71" HIGH BREATH GUARD
H24.5" | gap H14"
H62cm | gap H36.5cm
Fits large units
MG CIAN03 X _ XX

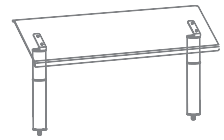

47" HIGH BREATH GUARD
H24.5" | gap H14"
H62cm | gap H36.5cm
Fits medium units
MG CIAN04 X _ XX



P. 16

MONITOR POST
L13.5" H40"
L34cm H102cm
Fits all units and screens up to 55"
MG CMAA01 GSXX

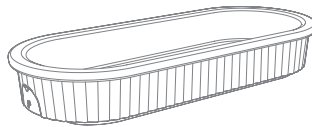

P. 38

PRO ICE BIN
L60" W25" H9"
L151cm W64cm H23cm
27Gal | 102L
Drain hose included
MG SADDPL 0901

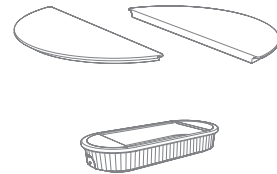

PRO ICE BIN END TRAYS
L21.5cm W52.5cm H2cm
X2 units
Fits Pro ice bin
MG STRYBP 0101

V-SHIELD SYSTEM - FREE STANDING BREATH GUARDS



NARROW SHIELD
W50cm H90cm | W20" H35½"
MGCDVO02CSAC



NARROW SHIELD WITH OPENING
W50cm H90cm | W20" H35½"
MGCDVO02CSAS



WIDE SHIELD
W89cm H90cm | W35" H35½"
MGCDVO01CSAC



WIDE SHIELD WITH OPENING
W89cm H90cm | W35" H35½"
GAP 6" 15cm
MGCDVO01CSAS



DOUBLE WIDE SHIELD
W178cm H90cm | W70" H35½"
MGCDVO03CSAC
for 6' | 180cm TABLE



EXTRA WIDE SHIELD
W228cm H90cm | W90" H35½"
MGCDVO05CSAC
for 8' | 244cm TABLE



DOUBLE WIDE SHIELD WITH OPENING
W178cm H90cm | W70" H35½"
MGCDVO03CSAS
for 6' | 180cm TABLE



EXTRA WIDE SHIELD WITH OPENING
W228cm H90cm | W90" H35½"
MGCDVO05CSAS
for 8' | 244cm TABLE

SEGMENTS



Brushed Stainless Steel

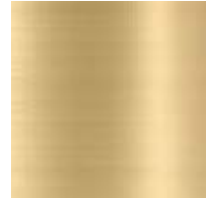

Brushed Brass



5.7" SEGMENT
H5.7" | H14cm
available in sets of:
1 / 2

1 piece

MG SLEGSS 02

MG SLEGBR 04

2 pcs

MG SLEGSS 05

MG SLEGBR 09



12" SEGMENT
H12" | H30cm
available in sets of:
1 / 2 / 8

1 piece

MG SLEGSS 01

MG SLEGBR 03

2 pcs

MG SLEGSS 04

MG SLEGBR 08

8 pcs

MG SLEGSS 15

MG SLEGBR 10



STANDARD SEGMENT
H25" | H63cm
available in sets of:
1 / 4

1 piece

MG SLEGSS 17

MG SLEGBR 14

4 pcs

MG SLEGSS 18

MG SLEGBR 15

LEGS

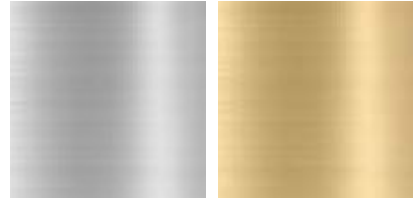

Brushed Stainless Steel

Brushed Brass



ADJUSTABLE LEGS
available in sets of:
1 single leg / 4 legs

1 piece	MG SLEGSS 13	MG SLEGBR 01
4 pcs	MG SLEGSS 14	MG SLEGBR 02

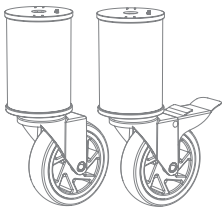

CASTERS
available in sets of:
1 with brake / without brake
4 casters (2 with brakes and 2 without)

1 piece <small>with brake</small>	MG SADDSS 04	MG SADDBR 06
1 piece <small>without brake</small>	MG SADDSS 03	MG SADDBR 05
4 pcs	MG SADDSS 01	MG SADDBR 04

CLASSIC RANGE TABLETOPS



High Density
Bamboo



Bengali Mango
Wood BHP



Grey Slate BHP

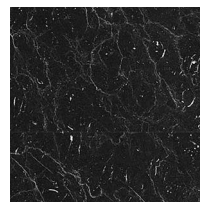

Nero Marquina
Marble BHP



MG SCTPBM 01

MG SCTPHW 01

MG SCTPHG 01

MG SCTPHB 01

LARGE RECTANGLE TOP

L71" W29.5"

L180cm W75cm



MG SCTPBM 02

MG SCTPHW 02

MG SCTPHG 02

MG SCTPHB 02

MEDIUM RECTANGLE TOP

L47" W29.5"

L120cm W75cm

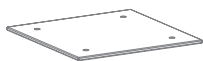

MG SCTPBM 03

MG SCTPHW 03

MG SCTPHG 03

MG SCTPHB 03

SMALL SQUARE TOP

L29.5" W29.5"

L75cm W75cm

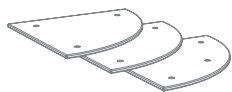

MG CILX01 BXXX

MG CILX01 WXXX

MG CILX01 GXXX

MG CILX01 MXXX

CORNER UNIT TOP SET

L29.5" W29.5"

L75cm W75cm

CLASSIC RANGE SHELF TOPS



High Density
Bamboo



Bengali Mango
Wood BHP



Grey Slate BHP

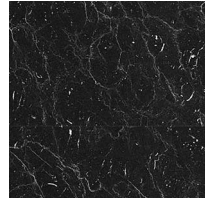

Nero Marquina
Marble BHP

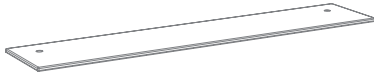

MG SCLSBM 02

MG SCLSHW 02

MG SCLSHG 02

MG SCLSHB 02

LARGE WIDE BAR SHELF

L71" W14.5"
L180cm W37cm



MG SCLSBM 01

MG SCLSHW 01

MG SCLSHG 01

MG SCLSHB 01

LARGE SHELF

L71" W9.5"
L180cm W24cm



MG SCLSBM 03

MG SCLSHW 03

MG SCLSHG 03

MG SCLSHB 03

MEDIUM SHELF

L47" W9.5"
L120cm W24cm



MG SCLSBM 05

MG SCLSHW 05

MG SCLSHG 05

MG SCLSHB 05

WIDE DISPLAY SHELF

L80" W12"
L203cm W30.5cm
connects 2 mid-hole display tabletops



MG SCLSBM 08

MG SCLSHW 08

MG SCLSHG 08

MG SCLSHM 08

SIDE SHELF

L29.5" W19"
L75cm W47.5cm

CREATIVE RANGE TABLETOPS



High Density
Bamboo



Bengali Mango
Wood BHP



Grey Slate BHP

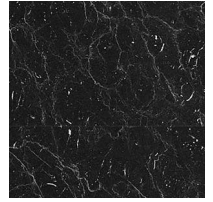

Nero Marquina
Marble BHP



MG SCTBBM 01

MG SCTBHW 01

MG SCTBHG 01

MG SCTBHB 01

LARGE ROUND TOP
L81.5" W41"
L207cm W104cm



MG SCTBBM 02

MG SCTBHW 02

MG SCTBHG 02

MG SCTBHB 02

47" EXTENSION TOP
L47" W21"
L120cm W54cm

CREATIVE RANGE SHELF TOPS



MG SCSVBM 01

MG SCSVHW 01

MG SCSVHG 01

MG SCSVHB 01

CURVED OUTER SHELF
L76" W27.5"
L193cm W70cm



MG SCSVBM 02

MG SCSVHW 02

MG SCSVHG 02

MG SCSVHB 02

CURVED INNER SHELF
L53" W26.5"
L135cm W68cm



MG SCSVBM 08

MG SCSVHW 08

MG SCSV HG 08

MG SCSVHB 08

EXTENSION SHELF
L47" W10"
L120cm W25cm

DISPLAY SHELF TOPS FOR CLASSIC AND CREATIVE RANGES



High Density
Bamboo



Bengali Mango
Wood BHP



Grey Slate BHP

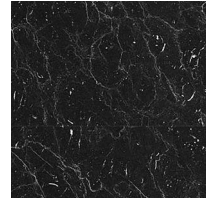

Nero Marquina
Marble BHP



30" ROUND TOP
Ø30" | Ø76cm

MG SCRTBM 01

MG SCRTHW 01

MG SCRTHG 01

MG SCRTHB 01



24" ROUND TOP
Ø24" | Ø60cm

MG SCRTBM 02

MG SCRTHW 02

MG SCRTHG 02

MG SCRTHB 02



18" ROUND TOP
Ø18" | Ø46cm

MG SCRTBM 03

MG SCRTHW 03

MG SCRTHG 03

MG SCRTHB 03



**LARGE TRIANGLE
DISPLAY SHELF**
L17" W17" | L44cm W44cm

MG SCLSBM 06

MG SCLSHW 06

MG SCLSHG 06

MG SCLSHB 06



**SMALL TRIANGLE
DISPLAY SHELF**
L14" W14" | L35cm W35cm

MG SCLSBM 07

MG SCLSHW 07

MG SCLSHG 07

MG SCLSHB 07



**LARGE OVAL
DISPLAY SHELF**
L20" W10" | L50cm W25cm

MG SSLFBM 03

MG SSLFHW 03

MG SSLFHG 03

MG SSLFHB 03



**SMALL OVAL
DISPLAY SHELF**
L16" W8" | L40cm W20cm

MG SSLFBM 04

MG SSLFHW 04

MG SSLFHG 04

S-SLF-HB-04

CLASSIC RANGE STAINLESS STEEL SPECIAL TABLETOP KITS



Brushed Stainless Steel

MG SSTPSS 03

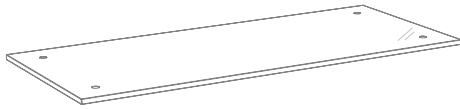

STAINLESS STEEL TOP

L71" W29.5"
L180cm W75cm

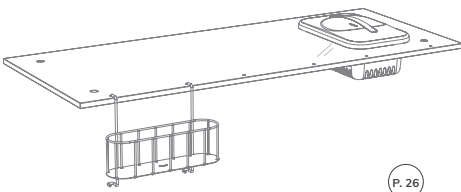

P. 26

MG CITC01 SXXX

PRO BAR TOP

L71" W29.5" | L180cm W75cm
Ice Bin: L16" W9" D6"
L41.5cm W23cm D15cm

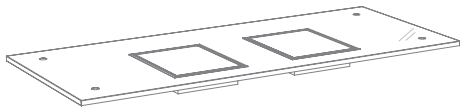

P. 14

MG CITD01 SXXX

COOKING DROP-IN TOP

L71" W29.5"
L180cm W75cm

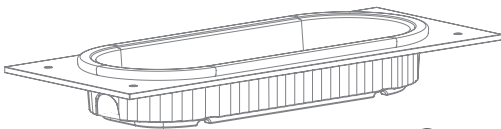

P. 28

MG CITC02 SXXX

MODULAR STAINLESS STEEL PRO BAR TOP WITH LARGE ICE BIN

L71" W29.5"
L180cm W75cm

CLASSIC RANGE STAINLESS STEEL SPECIAL TABLETOP UNITS

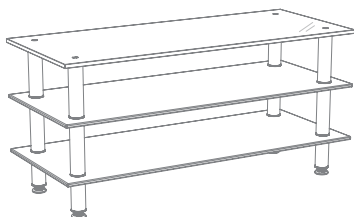

LARGE PRO UNIT
L71" W29.5" H35"
L180cm W75cm H88.5cm

MG CMLA05 _ _ X _

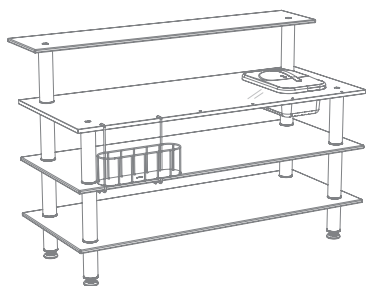

PRO BAR
L71" W29.5" H47.5"
L180cm W75cm H121cm

MG CMLC05 _ _ X _

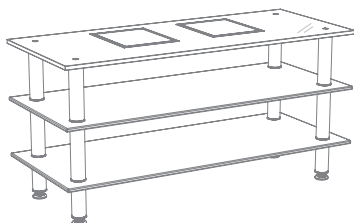

PRO COOKING INDUCTION
L71" W29.5" H35"
L180cm W75cm H88.5cm

MG CMLD01 _ _ X _

CLASSIC RANGE SPECIAL TABLETOP KITS

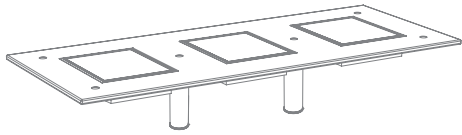

WARMING TRIPLE DROP-IN TOP
 L71" W29.5" | L180cm W75cm
 Comes with 2 x 12" support segment

MG CITD02 _ _ XX

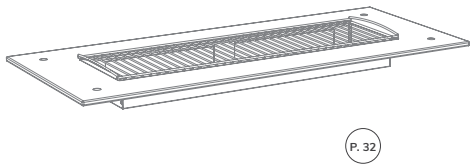

HEAT TABLETOP
 L71" W29.5" | L180cm W75cm
Grill: L48" W25" D6.5"
 L122cm W63cm D16cm

MG CITD04 _ XXX

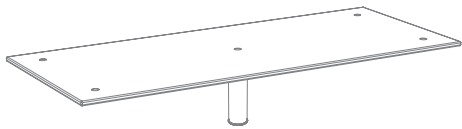

MID-HOLE DISPLAY TABLETOP
 L71" W29.5" | L180cm W75cm
 Comes with 1 x 12" support segment

MG CITB01 _ _ XX



High Density
Bamboo



Bengali Mango
Wood BHP



Grey Slate BHP

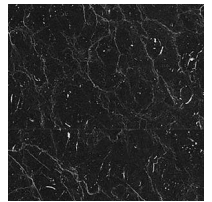

Nero Marquina
Marble BHP

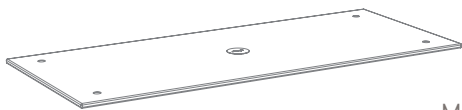

MARKET PANEL
 (Only for Market Square)
 L71" W29.5" | L180cm W75cm

MG SSTPBM 05

MG SSTPHW 05

MG SSTPHG 05

MG SSTPHB 05

CLASSIC RANGE SPECIAL TABLETOP UNITS

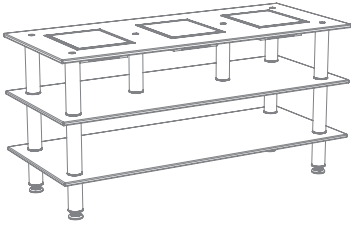

TRIPLE WARMING UNIT
L71" W29.5" H35"
L180cm W75cm H88.5cm

MG CMLD07 __ X _

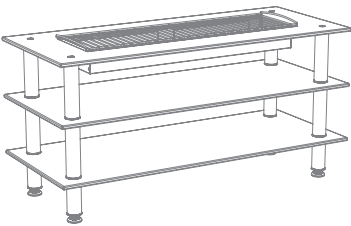

HEAT TABLE
L71" W29.5" H35"
L180cm W75cm H88.5cm

MG CMLD06 __ X _

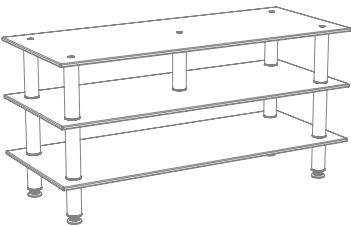

MID-HOLE DISPLAY UNIT
L71" W29.5" H35"
L180cm W75cm H88.5cm

MG CMLB09 __ X _



www.mogogo-buffet.com
info@mogogo-buffet.com

DISTRIBUTED BY:



CHECK OUT OUR OTHER COLLECTIONS



Cantine
DISPLAY CART



Roll'n
SERVICE CARTS



Canvas
SHELVING SYSTEM



CliX
TABLES



GraBIt
SIDE TABLES



V-Shield
SYSTEM



PoLo
TABLES